



ROLL-A-RAMP

Where Strength and Flexibility Meet

Owner's Manual

Please read entire manual BEFORE using your Roll-A-Ramp



Service Hotline: +65 6336 4036

Mobile: +65 978 61309

Email: greca@singnet.com.sg

Address:

149 Rochor Road #03-05

Fu Lu Shou Complex Singapore 188425

Blk 65A Jalan Tenteram

#01-03 Singapore 328985

Tool List:

Allen Wrench

(Supplied with your Roll-A-Ramp)

1/2" (13mm) Wrench

(Supplied with your Roll-A-Ramp)

Assembly:

Your Roll-A-Ramp has been shipped assembled to your specifications. Ramps over 10 ft. total length, please see addendum enclosed with this manual for final assembly instructions.

General Information

Roll-A-Ramp is lightweight, durable, and versatile. Fabricated of strong anodized aerospace aluminum, your Roll-A-Ramp will provide years of carefree convenience and accessibility when used properly and for its intended purpose.

Using Your Roll-A-Ramp

To use your Roll-A-Ramp, lay the rolled-up ramp on its side, remove the strap, and then unroll the ramp to its full length before putting it in place. To roll up your ramp, reverse the process, snap on the strap, and go. It's that simple!

You will notice that yellow pinch-point covers are secured on the head of each bolt. These covers are designed to keep your fingers out of the "pinch zone" and must be on at all times. Do NOT use your ramp(s) without ALL Pinch Point Covers in place. Never tamper with or remove these covers for any reason as injury may occur.

Ramp Placement: Important

To ensure safety and to prevent damage to your ramp, you must place the first load-bearing link of the elevated end of the ramp on the landing. The approach plate is not a load-bearing link. (See below)

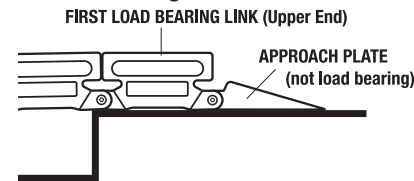

Notice that one end of each ramp is marked "Upper End." This end MUST ALWAYS be the elevated end of the ramp. The links on the upper end of your Roll-A-Ramp have a 1° camber and the links on the lower end have a 0° camber. This 0° loft at the lower end of the ramp allows the wheelchair, machine or other device to get on the ramp on a non-arched plane. As shown below, as the wheelchair goes up the Roll-A-Ramp,

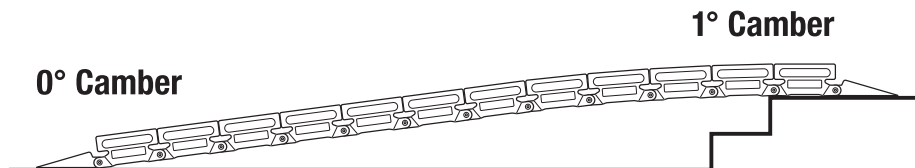

the arching links allow the user to more easily enter a van, porch, or doorway because of the more favorable approach angle. This also ensures clearance for lower devices.

Again, by placing the ramp with the "Upper End" at the elevated position, operation will be more favorable.

Changing Ramp Length

Your Roll-A-Ramp is designed so you may change the length by simply adding additional 1 foot links or removing links. This is done by removing the bolt and nut from the link on the lower end and inserting additional 1 foot links as needed. Please call your dealer, or contact Roll-A-Ramp toll free at 1-866-883-4722.

Versatility

Your lightweight Roll-A-Ramp rolls up and comes with its own handy strap/handle for convenient carrying and storage.

You can configure your Roll-A-Ramp for many different uses. Besides using it as a completely portable ramp system, you can modify your Roll-A-Ramp so the ramp is rigid or folds in the center for easy mounting into a vehicle. (Additional mount bracket required. See Accessories.)

To make your ramp fold in the middle you will want to have two pivot points per single ramp as illustrated.

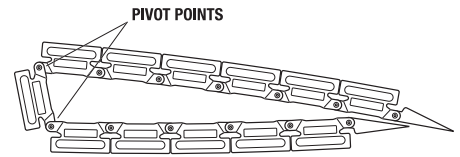

To convert your Roll-A-Ramp so that it folds in the middle:

- Lay the Roll-A-Ramp bottom side up.
- Add washers under nuts where the ramp will be rigid.
- Fully tighten all bolts using the 1/2" (13mm) Wrench and Allen Wrench. Do not tighten the bolts at the pivot point. You may find a socket wrench (1/2") works better.

Positive Lock Pins:

Positive Lock Pins are available and are used to easily and quickly separate your ramp into sections for easier handling and storage, and may be obtained from your dealer.

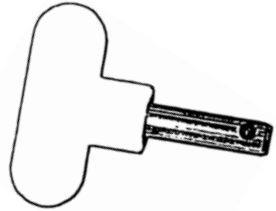

OR

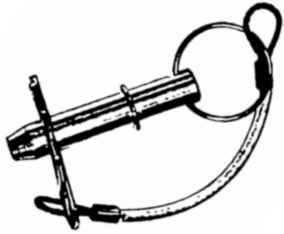

These pins may be inserted at any juncture where the links are joined together.

Simply remove the bolts using the tools provided with the ramp. To insert the pins, simply line up the holes where the bolts were removed, and insert the pins. **Ensure the pin is securely locked into place to ensure safety before using ramp. Do not replace yellow caution covers.**

Semi-permanent Installation:

These brackets allow you to secure your Roll-A-Ramp, yet still leaving it portable - simply lift the ramp to remove.

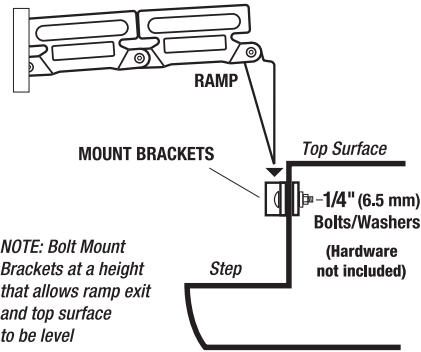

NOTE: Bolt Mount Brackets at a height that allows ramp exit and top surface to be level

The brackets illustrated above can be installed on the vertical section of the last step prior to the landing surface. Accommodates all ramp sizes (2 pair needed for 12" ramp). This creates a flush entrance/exit from the ramp.

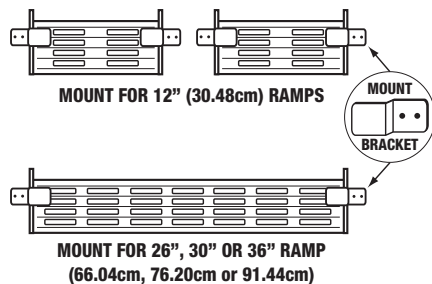

Support Stand Installation Instructions:

For ramps over 11 ft, support stands are recommended.

1. Set up ramp to desired location.
2. Place support stands under ramp at midway point (or every 6-8 ft) and adjust height so that support stands are same height as ramp.
3. Place ramp bracket onto the railing on the bottom of the ramp spanning between 2 links.
4. Tighten bolts for secure placement and adjust height with adjustment pins and fine adjustment threads. Then your new ramp system is ready to use.

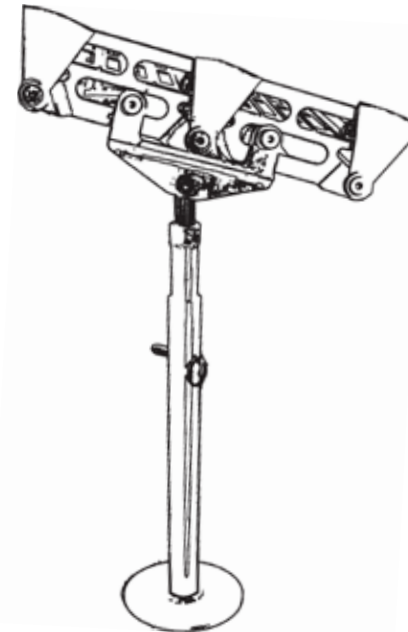

Support Stand

Spacers

Spacers for 12" (30.48cm) models: Spacers hold the ramps parallel to each other to assure that your 12" (30.48cm) Roll-A-Ramps stay at the correct width. We can provide you with spacers of various sizes to accommodate any axle width. Spacers are attached by simply snapping onto the ramp as illustrated below.

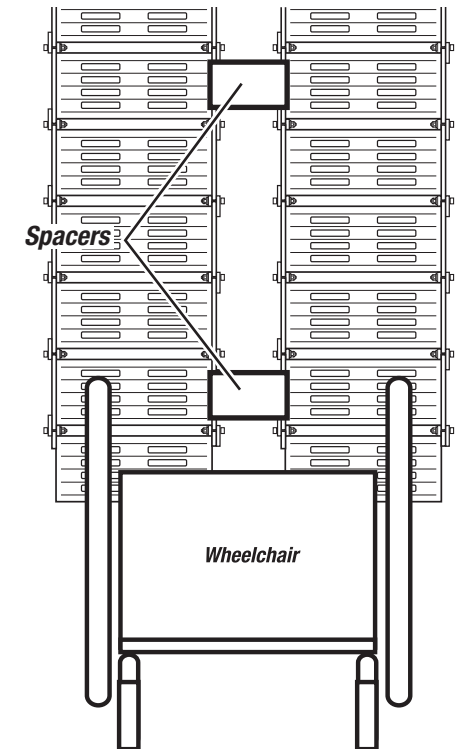
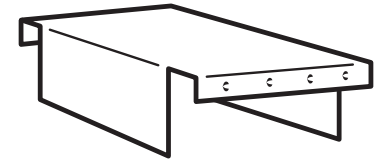

Distributed Weight Maximum Loads

Your Roll-A-Ramp has the maximum distributed weight load chart listed on each ramp. If you add links to your ramp, the maximum distributed weight load capacity may decrease as indicated in Chart 1.

Chart 1

Roll-A-Ramp Load Capacities

Note: Adding links decreases load capacity.



Ramp Width (inches/cm)	Overall Length (feet/cm)	Allowable Capacity (pounds/kg)
12/30.48	7/213.36	2000/909 pair
12/30.48	8/243.84	2000/909 pair
12/30.48	9/274.32	2000/909 pair
26/66.04	7/213.36	1000/455 ramp
26/66.04	8/243.84	1000/455 ramp
26/66.04	9/274.32	1000/455 ramp
30/76.20	7/213.36	1000/455 ramp
30/76.20	8/243.84	1000/455 ramp
30/76.20	9/274.32	1000/455 ramp
30/76.20	10/304.80	875/398 ramp
30/76.20	11/335.28	800/363 ramp
30/76.20	12/365.76	725/329 ramp
36/91.44	7/213.36	1000/455 ramp
36/91.44	8/243.84	925/420 ramp
36/91.44	9/274.32	850/386 ramp

Additional Notes:

- 1) Overall length includes approach plates.
- 2) Overall length can be adjusted by simply adding or removing links.



Full 10-Year Durable Medical Equipment Warranty

DT&J Inc. (Roll-A-Ramp) will replace any defective, damaged or worn-out parts for a period of 10 years from the purchase date by the original end user.

Products that have been subject to negligence, abuse, improper storage or handling, improper operation, unauthorized modifications, or damages beyond normal wear as determined by DT&J Inc. (Roll-A-Ramp), are not covered. If weight on such products is exceeded, the warranty will be void.

This warranty is exclusive and in lieu of all other express warranties or implied warranties, including but not limited to the implied duration of this warranty. DT&J Inc. (Roll-A-Ramp), shall not be liable for consequential or incidental damages whatsoever. This warranty applies to the original end user only.

Warranty issues will be handled by the dealer you purchased from, or call 1-866-883-4722.

Warranty Registration Card

Thank you for purchasing Roll-A-Ramp. We know that it will give you years of flexible, easier access to vehicles, homes, and other buildings. Please fill out and return this card so we may keep you informed about new Roll-A-Ramp products, accessories, and company news. We will NOT share your information with any third parties.

Name: _____

Address: _____

City, State/Province: _____

ZIP or Postal Code: _____

E-mail: _____

Phone: _____

Date of Purchase: _____

Purchased From: _____

Model

Length

12" (30.48cm) Pair _____ ft/cm.

26" (66.04cm) _____ ft/cm.

30" (76.20cm) _____ ft/cm.

36" (91.44cm) _____ ft/cm.

Manual Bi-Fold _____ 26" _____ 30"

Powered Minifold _____ Corded _____ Wireless Remote

Powered Autofold _____ Corded _____ Wireless Remote



ROLL-A-RAMP

Where Strength and Flexibility Meet